

# EZ-BULK 43 Series

## 275 Gallon Recyclable Liquid Bulk Container

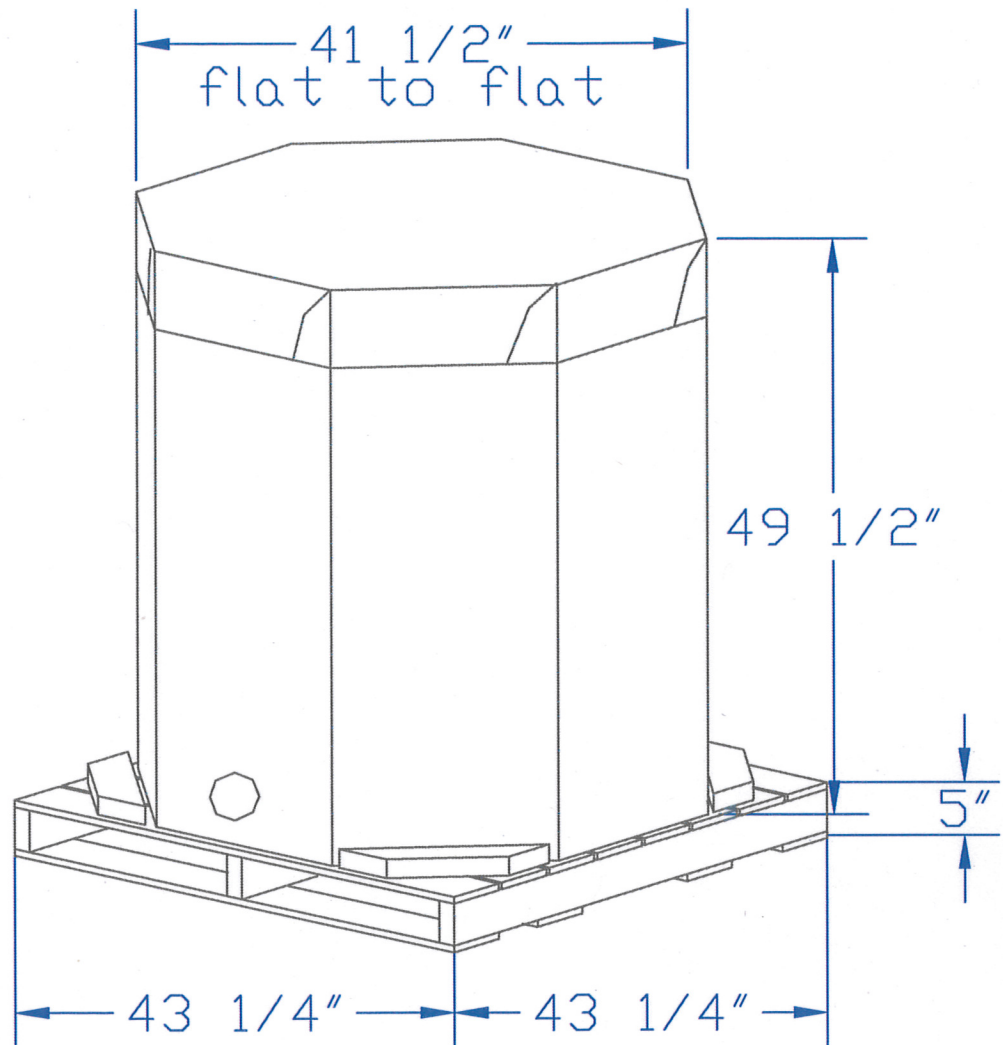

Approx. tare weight without pallet = 34 lbs



6127 Willowmere Drive

Des Moines, Iowa 50309 USA

[www.paper-systems.com](http://www.paper-systems.com)

[psi@paper-systems.com](mailto:psi@paper-systems.com)

ph. 1-515-280-1111

fax 1-515-280-9219