

EZ-BULK 48 x 40 Series
275 Gallon Recyclable Liquid Bulk Container

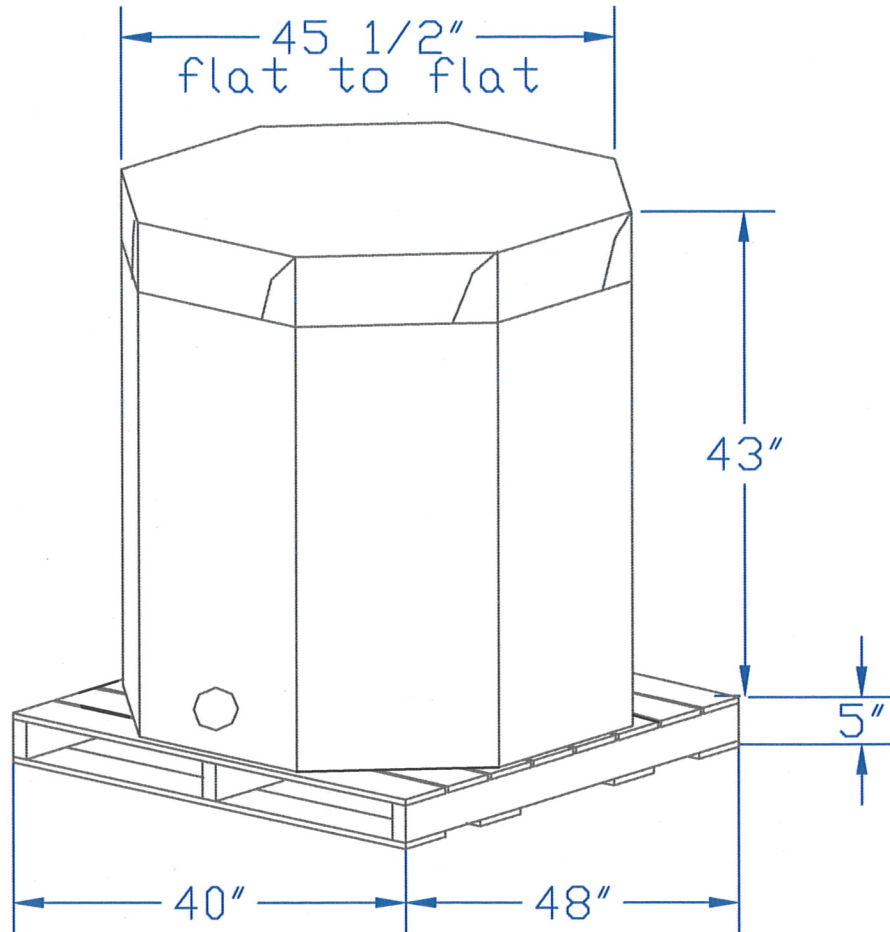

Approx. tare weight without pallet = 46 lbs



6127 Willowmere Drive

Des Moines, Iowa 50309 USA

www.paper-systems.com

psi@paper-systems.com

ph. 1-515-280-1111

fax 1-515-280-9219